



# Apex Locator

## Instruction Manual

Model: A7



RF-APL-M001-1.2

<https://www.alandental.com>

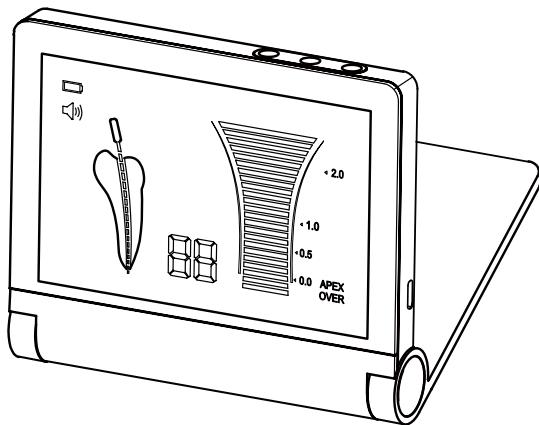

For your safety and the safety of your patients please read this user manual carefully before use and file for future reference.

This manual is published by Manufacturer.

We do not guarantee its contents and reserves the right to amend at anytime without prior notice, amendments will be published in new editions of this manual.

# Contents

1. Intended Use .....	1
2. Precautions .....	1
3. Contraindication .....	2
4. Package Contents .....	3
5. Component .....	4
6. Installation .....	7
7. Operation .....	8
8. Audio Alarm Volume Control.....	11
9. Maintenance .....	11
10. Charging Battery .....	13
11. Regular Maintenance Checks.....	14
12. Trouble Shooting .....	15
13. Specifications .....	20
14. Classification of Equipment.....	21
15. Operation Principle .....	21
16. Declaration of Conformity.....	22
17. Transportation and Storage Environment.....	22
18. Symbols.....	22
19. Warranty .....	23
20. Disposing Product .....	23
21. EMC Information .....	24
(Electromagnetic Compatibility Information) .....	24

## 1. Intended Use

### Intended use:

determination of the apical foramen position and measurement of the root canal length.  
The product is only to be used in dental surgeries by qualified dental personnel.

## 2. Precautions

- All precautions should be read and understood before use.
- Equipment is only to be used for its specified intended use.
- Safety instructions are provided in order to prevent the risk of personal injury or damage to the device and are classified as below in accordance with the level of potential risk.

 **WARNING:** Indicates a hazard that may result in serious injury/device damage if instructions are not correctly followed.

 **CAUTION:** Indicates a hazard that may result in mild to moderate injury/device damage if instructions are not correctly followed.

 **WARNING:**

- Use this product in accordance with its intended use and proper method of use.
- This product is not waterproof. Avoid water or chemical solutions on the control unit as it may cause electric shock due to a short circuit.
- The scale indication on the screen does not represent a distinct length or distance in mm or other linear units. It simply indicates the file's progression towards the apex.
- Do not expose to or dispose of the battery in a fire.
- Be sure to prevent the lip hook , file clip , file probe and their connector parts from having contact with household power supply sources (such as electrical outlets) as it may cause an electric shock.
- The components in the product package are delivered in a non-sterile condition, be sure to sterilize the file clip, file probe and lip hook by autoclave sterilization prior to use and after each patient.
- Do not operate close to patients with cardiac pacemakers as there is a danger that it may affect the pacemaker.
- Keep away from explosive substances and flammable materials.

**CAUTION:**

- Do not keep using the product when the battery indicator "  " is flashing. Normal operation or indication may not be performed. Please recharge the battery.
- Should the product function abnormally during operation, cease operation immediately.
- Do not use the product by connecting or integrating into other medical devices.
- Do not drop or allow impact on the product. This may result in personal injury or damage to the unit.
- Avoid using chemical solutions on the lip hook, file probe or file clip during procedures. Use of solutions may cause inflammation.
- When gripping the metallic part of a file or reamer with the file clip, grip the upper part (near the handle). If the lower part (blade transition part and blade part) is gripped, the root canal length cannot be correctly measured and the tip of the file clip may be broken.
- Do not use or leave the product in a high-temperature environment such as under strong direct sunlight, or next to equipment that produces heat as it may cause overheating or fire due to a failure of the internal circuit.
- Do not attempt to disassemble the product nor tamper with the mechanism except as recommend by manufacturer in this User manual.
- This device is for indoor use only.
- Keep the control unit on a level surface.
- If the product is not used for a long period check it is functioning correctly before using on a patient.
- Portable and mobile RF communications equipment can affect Medical Electrical equipment. Do not use RF equipment near the product.
- During operation the Apex Locator may interfere with computers, LAN cables or may cause noise in radio receivers nearby.
- Installation and use of this product requires special precautions regarding EMC according to the EMC information.
- Use only original accessories with this device.
- The apical position is indicated on the screen with "00". In order to avoid over instrumentation, it is suggested to subtract 0.5mm from the reading when determining the working length for shaping.

- Always dry the cavity entrance with a cotton pellet in order to obtain an accurate measurement.
- Users are responsible for the operational control, maintenance and continual inspection of this product.
- The battery can be replaced, please contact our distributor if a replacement battery is required.

### 3. Contraindication

The Apex Locator is not recommended for use:

- In patients who have a pacemaker or other implanted electrical devices or have been cautioned by their physicians against the use of small electric appliances such as shavers, hair dryers etc.
- In Patients allergic to metals.
- Children.

### 4. Package Contents

Apex Locator is composed of a control unit, AC adapter, Plug adaptor, measuring wire, lip hook, file clip, file probe .

#### Accessories



a). File Clip



b). Measuring wire



c). Battery



d). Lip Hook



e). File Probe



f). AC adapter

## Accessories list

No.	Name	Quantity	Consumable?	Can be sterilized?
a	File clip	4 PCS	YES	YES
b	Measuring wire	1 PCS	YES	NO
c	Battery	1 PCS	NO	NO
d	Lip hook	4 PCS	YES	YES
e	File probe	4 PCS	YES	YES
f	AC adapter	1 PCS	NO	NO

## 5. Component

### 5.1 Control Unit

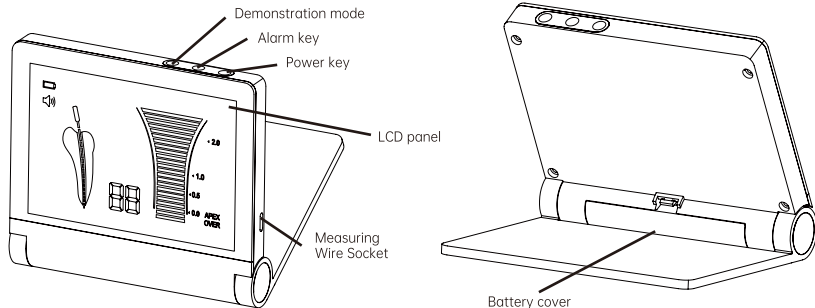



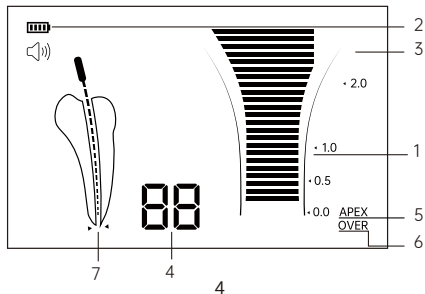

<b>LCD Panel</b>	Displays the position of the file tip, remaining battery level and alarm sound volume
<b>Power key</b>	When the Power key is pressed, the power turns on sounding an alarm, then the LCD panel lights up, press the Power key again, the power and the LCD panel turns off.
<b>Alarm key</b>	When the Alarm key is pressed, the alarm audio volume can be adjusted (rotation of OFF->Low->Medium->High).
<b>Measuring wire socket</b>	Socket to which the measuring wire is inserted.
<b>Battery cover</b>	Secures battery in place.
<b>Charging light</b>	The light will remain on when battery is charging
<b>Demonstration mode</b>	Press the button to demonstrate the measurement process
<b>Charging socket</b>	Socket to which the AC adapter is inserted

## 5.2 LCD Panel





<b>Bar graph</b>	Displays the approximate position of the end of the file
<b>Batter indicator</b>	Displays the remaining battery level. When the Battery indicator flashes, immediately recharge the device with AC adapter
<b>Alarm indicator</b>	Displays the alarm audio volume (rotation of OFF  ->Low  ->Medium  ->High  )
<b>Number display</b>	Displays the present position from the end of the root canal in numerical value. When the value displays "10" to "05", an alarm corresponding to each value sounds. When the value reaches "04" to "00", a short alarm sounds with "APEX" displayed on the LCD panel. When the values reaches "-1" to "-3", a shorter alarm sounds with "OVER" displayed on the LCD panel
<b>Apex indicator</b>	Turns on when the value representing the present position of the file end reaches "00"
<b>OVER Display</b>	Turns on when the value representing the present position of the file end reaches "-1"
<b>Measurement indicator</b>	Indicates the files position in the root canal

\* 4 is not a value to show the actual distance from the end of the root canal in the unit of mm. It is to be used as indication for measurement.

## 6. Installation

1) Connect the measuring wire: securely insert the plug of the measuring wire into the Measuring wire socket on the unit.(Fig.2)

- 2) Connect the file clip: connect the plug of the file clip to either plug of the measuring wire. (Fig.3)
- 3) Connect the lip hook: connect the lip hook to the other plug of the measuring wire. (Fig.3)

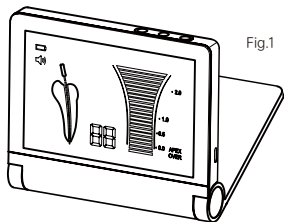

Fig.1



Fig.2



Fig.3

4) Make the lip hook touch the bent section of the file clip (Fig.4), the screen will display "OVER", (as show in Fig.5 c), otherwise, it means the file clip or the measuring wire is damaged, and should be replaced.

5) Display explanation

- "10 to 05", Green bar graph and/or low frequency sound: File has reached the front region of the Apex;
- "04 to 00", Yellow bar graph and/or middle frequency sound: File is very close to the Apex;
- "-1 to -3", Red bar graph and/or high frequency sound: File has exceeded the Apex.

### Display Screen explanation

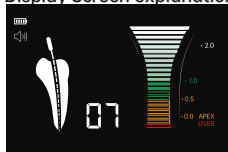

a. The file has reached the front region of the apex



b. The file is very close to the apex



c) The file has already exceeded the Apex

Fig.5

## 6) Demonstration mode

Demonstration mode tracks the movement of the file

- a. Pull out the measuring wire and adapter.
- b. Turn on Apex Locator
- c. Press "▶▶" button for 2 seconds to enter demonstration mode

Demonstration mode will be exited by finishing demonstration or pressing demonstration mode button.

# 7. Operation

## 7.1 Preparation

7.1.1 The use of apex locators alone, without a preoperative and postoperative radio graph, is not a recommended practice as apex locators may not work properly in all conditions. It is recommended to take an X-ray prior to the use of the Apex Locator, to compare the information given by both devices.

7.1.2 The dentist should have a good understanding of the tooth and root canal in question

7.1.3 The root cavity should be sufficiently exposed and the root should be unblocked.

7.1.4 The largest file that can correctly reach the apex should be selected.

7.1.5 Avoid contact between the file, file clip and the gingiva or any metal crown and bridge appliances. If the crown of the tooth is broken and there is a possibility of the gingiva contacting either the file, file clip or a probe, an incorrect reading may occur. An isolating barrier around the rim of the broken tooth must be created before proceeding with the Apex location.

7.1.6 Dry canals should be treated with an irrigation solution such as saline or hydrogen peroxide. Access to the cavity should then be air dried or wiped dry with a cotton pellet.

7.1.7 If there is bleeding from the root canal or apical foramen, it must be stopped before a correct measurement can be taken.

7.1.8 Canals must be cleaned of all remnants after root canal treatment before measurement can be taken.

7.1.9 Accessories such as file clips, lip hooks and file probes should be clean and free from any chemical disinfectant or medical solution residue.

7.1.10 Mark the treated tooth and record the information on the patients medical records. Be careful to

make sure the tooth is marked in a practical and most resilient part of the tooth.

7.1.11 The root canal must be cleared of any pulp or necrotic tissue and there must be no inflammation or infected material surrounding the apex.

7.1.12 The following cases are not for use with the apex locator.

a) The measurement length of the canal may be shorter than its real length due to root hypoplasia and thus a true reading is not possible

b) A crack in the root may allow electric leakage thus affecting accuracy of the reading

7.1.13 An X-ray shot at a difficult or unusual angle may sometimes cause the illusion that the file tip has not reached the apex. Results of the Apex Locator and X-ray may possibly not correlate falsely indicate that the file tip has not reached the root canal tip. (Fig. 6)

## 7.2 Operating Procedure

7.2.1 Grip the file inserted in the root the handle) of the file's metallic part.

7.2.2 Hang the lip hook on a corner of



canal with the file clip. Grip the upper part (near (Fig.7)

the patient's mouth. (Fig.8)

Fig.7

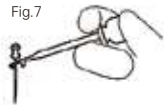

Fig.8

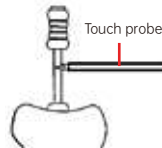
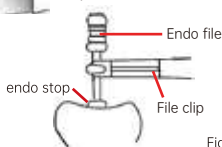

Fig.9

7.2.3 Insert the file into the canal and push it slowly towards the Apex. A continuous alarm will sound when the file is less than 2mm from the apex. Gloves must be worn to avoid contact of the operators skin and metal shank of the file.

7.2.4 The "APEX" will be indicated when the screen displays "00" but as previously stated 0.5mm should be subtracted from the reading so as to not over instrumentate.

7.2.5 When the file reaches this point, adjust the endo stop and remove the file. By measuring the distance between the endo stop and the tip of the file, the working length of the canal can be determined.

7.2.6 The file probe may also be used instead of the file clip to touch the file when working on posterior to determine the working length of the canal. (Fig.9)

7.2.7 After use, press the Power key for approximately one second to turn off the power (the alarm sounds and the LCD panel turns off). The device will shut down automatically after 5 minutes if unit is not in operation.

7.2.8 Remove the file from the file clip.

7.2.9 Remove the lip hook and file clip from the measuring wire.

7.2.10 Remove the measuring wire from the control unit.

 **CAUTION:** Never hold the measuring wire when removing the lip hook and file clip from the measuring wire. Always hold the connector section.

## 8. Audio Alarm Volume Control

Alarm audio volume can be adjusted to "OFF " , "Low " , "Medium " , and "High " .

1) press the Alarm key.

2) The Alarm Indicator on the LCD panel and the sound volume will change.

3) Each time the key is pressed the sound volume changes.

NOTICE

The last setting is stored when the control unit is switched off.

## 9. Maintenance

### 9.1 Cleaning

Preparation prior to cleaning

1. Remove the file clip and lip hook from the measuring wire.

2. Remove the measuring wire from the control unit.

3. Check for damage on each cord or deformation on each connector.

Cleaning

1. Rinse accessories thoroughly with clean suitable water, then wipe clean with alcohol-immersed cotton or cloth.

2. Repeat until accessories are visibly clean.

Note:

- a. Clean and sterilize the accessories before each use to prevent any contamination. This includes the first use as well as any subsequent use.
- b. Accessories that should be cleaned include: measuring wire, file clip, lip hook, file probe.
- c. Do not use highly acidic water to immerse or clean .



**CAUTION:**

Non observance of the following precautions could lead to the deterioration or failure of the accessories. Be sure to follow these precautions when cleaning the accessories.

- When cleaning the product never use solvent such as benzine or thinner.
- Do not use a chlorinated cleaner.
- Do not clean the product with an ultrasonic cleaning apparatus.
- For your own safety, please wear personal protective equipment (gloves, glasses, mask)
- After cleaning the measuring wire, make sure to dry the connector part of the measurement wire.

### 9.2 Sterilization of the file clip, lip hook and file probe

**Note:** Sterilize file clip ,file probe and lip hook by autoclave sterilization, other parts Apex Locator can not be sterilized.

**Autoclave Procedure:**

- 1) Insert into an autoclave pouch.
- 2) Seal the pouch.
- 3) Sterilize at 134°C (273°F) for 10 mins and a minimum drying cycle of 30 mins.
- 4) The product should remain in a sealed pouch until required for use.



**CAUTION:**

- The product must be cleaned before sterilization.
- Do not heat or cool the product too quickly. Rapid change in temperature could cause damage to the product.
- Do not use Autoclaves exceeding 138°C during sterilization.
- We recommends sterilization according to EN13060, class B. Always follow autoclave manufacturer's

instructions for use.

- Do not touch the product immediately after autoclaving as it will be very hot and must remain in a sterile condition.
- Reprocessed products should be stored, protected from dust with minimum exposure to germs in a dry, dark and cool place.
- Autoclave sterilization is the only agreed method to correctly sterilize this product. The validity of other sterilization methods is not confirmed or guaranteed.
- Resistance to reprocessing: file clip: 200 cycles , other accessories have no cycle limitation, but should be replaced when no longer in usable condition.  
(reprocessing cycles include cleaning and sterilization).

## 10. Charging Battery

Do not use the Apex Locator whilst the indicator is flashing. Charge battery as below:

- 1) Connect the AC adapter to the Charging Socket of the device, then insert AC adapter plug into supply power socket.
- 2) The Apex Locator will take approximately 2-3 hours to fully charge.

### **Attention:**

- a. Orange light indicates charging and will turn green once unit is fully charged.
- b. Please do not use the device when it is charging.
- c. We provide a plug adaptor for certain target markets, if the AC adapter can not match the supply power socket, you can insert the plug of AC adapter into the Plug adaptor, then insert the Plug adaptor into the supply power socket.



### **CAUTION:**

- Avoid shorting the battery.
- Do not disassemble or tamper with the battery.
- Use the AC adapter provided by manufacturer (complies with IEC 60601-1) to charge the device, never use a modified or damaged charger.
- Batteries will discharge over time if Apex Locator is not used. Always recharge if the unit has not been

used for extended periods.

- Only the NCM 14500 DC 3.6V/850mAh Rechargeable Li-ion Battery Cells which have passed the IEC 62133 certification can be used.

3) If you need to replace battery please contact us or your dealer.

How to install the battery:

- a. Open the battery housing
- b. Insert battery connector into the square notch
- c. Make sure it is firmly installed by gently pulling the battery
- d. Reinstall the battery housing

Note: the square notch is an anti-mistake design, if the polarity is reversed, the battery can not be installed.

## 11. Regular Maintenance Checks

Regular maintenance should be performed every 3 months as per the below chart.

If any abnormalities are found, immediately contact our authorized dealer or us.

<b>Points to check</b>	Process
<b>ON/OFF operation</b>	Check that the power turns ON and OFF correctly
Remaining battery level	Check that the Battery indicator does not flash. If the display flashes, recharge the battery following the instruction in "10.Charging battery"
Alarm sound volume	Press the Alarm key and check that the alarm audio volume changes. (rotation of OFF->Low->Medium->High)
Connector part	Check for debris or corrosion on the lip hook or connector terminals of the cable



Product operation	Check with the tester, that the cable and the control unit operate properly, following the instruction in "6. Check before Treatment and Installation"
-------------------	--

\* See trouble shooting chart if problems are discovered

## 12. Trouble Shooting

When a problem is detected, check the following again before requesting a repair.

Malfunction	Cause	Solution
The power does not turn on	Battery is not inserted	Insert battery
	Battery is not correctly inserted	Correctly insert the battery
	The battery level is low	Recharge the battery
Root canal length measurement cannot be performed	The measuring wire or other connectors are not properly connected.	Securely insert the connector Connect the lip hook and file clip and make the lip hook touches the bent section of file clip to check whether the device has been connected correctly.(refer to"6. Check before Treatment and Installation". )
Alarm sound volume is low	The alarm sound volume is adjusted to "OFF".	Check the alarm sound volume.
The LCD panel does not display	The battery level is low	If the LCD panel does not display after the battery is charged, failure of the LCD panel is suspected

Bar graph is not stable	The lip hook is not firmly in contact with the membrane of the patient's oral cavity	Adjust the lip hook position so that it correctly contacts the membrane in the oral cavity
	Perforation of the canal or an adjacent surface has caries	Remove the file , close the perforation and repair the caries, then repeat the apex detection procedure, carefully inserting the file in canal
	Large lateral canal	Try continuing the procedure by gently advancing the file
	The file is in contact with the gingiva	When the file contacts the gingiva the entire bar graph will light be lit up. Check if the file is in contact with gingiva
	The file is in contact with a metal prosthesis.	When the file contacts a metal prosthesis, the measured current flows to the gingiva or periodontal tissues and the bar graph moves.Check if the file has contacted a metal prosthesis
	Current leakage to the gingiva is occurring due to a major collapse of the crown	Form a matrix around the tooth to prevent current leakage to the gingiva

Bar graph is not stable	The file clip is not clean or is damaged	Replace or clean the file clip
Bar graph does not move	The root canal is closed	Bar graph operates correctly when the file reaches the apical constriction. In this case, always check in combination with X-ray photography
	The inside of the root canal is extremely dry.	Moisten the root canal with a saline solution
	Bad electrical contact	Perform the cable connection test as described in "6. Check before Treatment and Installation"
Bar graph does not move	The connection hook of file clip is not properly connected to the file	Place the connection hook on the metal part of the file below the plastic handle
	In the case of retreatment: residue from old filling material may be blocking the root canal	Remove old root filling material residues prior to measuring

Bar graph does not move	Root canal may be blocked by remnants of medical products (e.g. calcium hydroxide)	Rinse the root canal with NaCl solution. Dry the access cavity with a cotton pellet/air-blower
	The selected file is too small for a large root canal	Use the largest file possible for the canal to produce the most accurate result
	Electronic malfunction	Contact your distributor or us
Display indications are incorrect, i.e. unit displays that "APEX" is reached before it has	Short circuit due to excess liquid(irrigation solution, saliva or blood) in the pulp chamber	Dry the access cavity with a cotton pellet/air blower. In case of excess bleeding, wait until it has stopped
	A direct contact of the file with the gingiva proliferations or metal restorations (crown, amalgam filling)	For isolation: A) Do adequate preparation filling. B) Use a rubber dam or isolate the file by placing 2-3 silicone stoppers on it

If none of these are applicable or if the trouble is not fixed after the appropriate action has been taken, a failure in this product is suspected. Contact our Authorized Dealer.

## 13. Specifications

Model	Apex Locator
Input (charge the battery)	DC 5V 1A

AC Adapter: UES06WZ-XXXYYYSPA		100-240V AC 50Hz/60Hz	
Battery: NCM 14500 Rechargeable Li-ion Battery		DC 3.6V/850 mAh	
Working Voltage		DC 3.6V	
Working Current		DC: 0.13-0.14A	
Rated Power		≤0.5W	
Measurement Voltage		AC 200mV	
Measurement Current AC		AC 100μA	
Screen		5.1" LCD ( 110 mm x 70 mm )	
Display		Reflective colour LCD display	
Alarm		The beeper will sound when the file is less than 2 mm from the apex	
Control Unit	Dimensions	L130 mm × W112 mm × H23.5 mm	
	Weight	370 gms ( including battery )	
Use Environment	Temperature :5°C - +40°C	Humidity: 30%-75%RH	Atmospheric pressure: 70kPa-106kPa

## 14. Classification of Equipment

- Type of protection against electric shock:
  - Class II internally powered equipment
- Degree of protection against electric shock:

- Type BF applied part
- Method of sterilization recommended by the manufacturer:
  - See "9-2 Sterilization of the file clip, lip hook and file probe"
  - Degree of protection against ingress of water as detailed in the current edition of IEC 60529:
- Control unit: IPX0
- Degree of safety of application in the presence of a flammable anesthetic mixture with air or with oxygen or nitrous oxide:
  - Equipment not suitable for use in the presence of a flammable anesthetic mixture with air or with oxygen or nitrous oxide.
- Mode of operation:
  - Continuous operation

## 15. Operation Principle

The lip hook , file clip and file probe are used as electrodes and are attached to the patient's mouth and the operating instrument such as a file. The motion of the instrument in the root canal causes an impedance variation between the pair of electrodes. The position of the apical foramen is detected by measuring the impedance variation using two different frequencies

## 16. Declaration of Conformity











We declare that the dental apex locator complies with following normative documents: EN 60601-1; EN 60601-1-2; EN 80601-2-60; EN 62304; EN 60601-1-6; ISO 10993.

## 17. Transportation and Storage Environment

Keep away from environmental conditions including but not limited to harmful chemicals like acids and alkali. Temperature: -20°C - +40°C, Humidity: 10% - 93%, Atmospheric Pressure: 70kPa - 106kPa

## 18. Symbols



	Marking on the outside of Equipment or Equipment parts that include RF transmitters or that apply RF electromagnetic energy for diagnosis or treatment		
	Following the waste of electric and electronic equipment (WEEE) Directive (2002/96/EC) for product and accessory disposal		
<b>IPX0</b>	Symbol for "Protection from ingress of liquids into device"		
	Type BF applied part		Follow operating instructions
	Manufacturer		Temperature limitation
	Authorized representative in the European community		Power key
<b>SN</b>	Symbol for "Serial Number"		Demonstration mode
	Batch code		Direct current

## 19. Warranty

Our products are warranted against manufacturing errors and defects in materials. We reserve the right to analyze and determine the cause of any problem. Warranty is voided should the product be not used correctly or for the intended purpose or has been tampered with by unqualified personnel or has had non parts installed. Replacement parts are available for seven years beyond discontinuation of the model.

## 20. Disposing Product

In order to avoid the health risks of operators handling of medical equipment, as well as the risks of environment contamination caused thereof, a surgeon or a dentist is required to confirm the equipment is sterile.



Following the waste of electric and electronic equipment (WEEE) Directive (2002/96/EC) for product and accessory disposal. If you have any queries, please refer to the local authorities responsible for waste disposal.

### NOTES

Please follow local authority guidelines for disposal of batteries and used equipment.



To protect the environment, dispose of empty battery at appropriate collection sites according to national or local regulations.

Dispose of battery at public collection point in the EU countries-2006/66/EC

## 21. EMC Information

### (Electromagnetic Compatibility Information)

Guidance and manufacture's declaration – electromagnetic emission		
The product is intended for use in the electromagnetic environment specified below. The customer or the user of the Apex Locator should be assured that it is used in such an environment.		
Emission test	Compliance	Electromagnetic environment – guidance



RF emissions CISPR 11/EN55011	Group 1	The product uses RF energy only for its internal function. Therefore, its RF emissions are very low and are not likely to cause any interference in nearby electronic equipment.
RF emission CISPR 11/EN55011	Class B	The product is suitable for use in all establishments, including domestic establishments and those directly connected to the public low-voltage power supply network that supplies buildings used for domestic purposes.
Harmonic emissions EN/IEC 61000-3-2	Class A	
Voltage fluctuations/flicker emissions IEC 61000-3-3	Complies	

#### **Guidance and Manufacture's Declaration – Electromagnetic Immunity**

The product is intended for use in the electromagnetic environment specified below. The customer or the user of the Apex Locator should be assured that it is used in such an environment.

<b>Immunity test</b>	<b>IEC 60601 test level</b>	<b>Compliance level</b>	<b>Electromagnetic environment – guidance</b>
----------------------	-----------------------------	-------------------------	---

Electrostatic discharge (ESD) IEC 61000-4-2	$\pm 6$ kV contact $\pm 8$ kV air	$\pm 6$ kV contact $\pm 8$ kV air	Floors should be wood, concrete or ceramic tile. If floors are covered with synthetic material, the relative humidity should be at least 30%.
Electrical fast transient/burst IEC 61000-4-4	$\pm 2$ kV for power supply lines $\pm 1$ kV for input/output lines	$\pm 2$ kV for power supply lines	Mains power quality should be that of a typical commercial or hospital environment.
Surge IEC 61000-4-5	$\pm 1$ kV line(s) to line(s) $\pm 2$ kV line(s) to earth	$\pm 1$ kV differential mode	Mains power quality should be that of a typical commercial or hospital environment.

### Guidance and Manufacture's Declaration – Electromagnetic Immunity

The product is intended for use in the electromagnetic environment specified below. The customer or the user of the Apex Locator should be assured that it is used in such an environment.

Immunity test	IEC 60601 test level	Compliance level	Electromagnetic environment – guidance
---------------	----------------------	------------------	--

Voltage dips, short interruptions and voltage variations on power supply input lines IEC 61000-4-11	<5% UT (>95% dip in UT)for 0.5 cycle 40% UT (60% dip in UT)for 5 cycles 70% UT (30% dip in UT)for 25 cycles<5% UT (>95% dip in UT)for 5 sec	<5% UT(>95% dip in UT)for 0.5 cycle 40% UT(60% dip in UT) for 5 cycles 70% UT(30% dip in UT) for 25 cycles<5% UT (>95% dip in UT)for 5 sec	Mains power quality should be that of a typical commercial or hospital environment. If the user of the A7 requires continued operation during power mains interruptions, it is recommended that the A7 be powered from an uninterruptible power supply or a battery.
Power frequency (50Hz/60Hz)magnetic field IEC 61000-4-8	3 A/m	3.15 A/m	Power frequency magnetic fields should be at levels characteristic of a typical location in a typical commercial or hospital environment.
NOTE UT is the a.c. mains voltage prior to application of the test level.			

#### Guidance and Manufacture's Declaration – Electromagnetic Immunity

The product is intended for use in the electromagnetic environment specified below. The customer or the user of the Apex Locator should assure that is used in such an environment.

Immunity test	IEC 60601 test level	Compliance level	Electromagnetic environment – guidance
---------------	----------------------	------------------	--

Conducted RF IEC 61000-4-6	3 Vrms 150 kHz to 80 MHz	3 Vrms 150 kHz to 80 MHz	<p>Portable and mobile RF communications equipment should be used no closer to any part of the product, including cables, than the recommended separation distance calculated from the equation applicable to the frequency of the transmitter. Recommended separation distance</p> $d = 12\sqrt{P}$
Radiated RF IEC 61000-4-3	3 V/m 80 MHz to 2.5 GHz	3 V/m 80 MHz to 2.5 GHz	$d = 12\sqrt{P}$ 80 MHz to 800 MHz $d = 2,3\sqrt{P}$ 800 MHz to 2,5 GHz <p>Where P is the maximum output power rating of the transmitter in watts(W) according to the transmitter manufacturer and d is the recommended separation distance in metres (m).  Field strengths from fixed RF transmitters, as determined by an electromagnetic sitesurvey<sup>(a)</sup>, should be less than the compliance level in each frequency range<sup>(b)</sup>.  Interference may occur in the vicinity of equipment marked with the following symbol: </p>

NOTE 1: At 80 MHz and 800 MHz, the higher frequency range applies.

NOTE 2: These guidelines may not apply in all situations. Electromagnetic propagation is affected by absorption and reflection from structures, objects and people.

a: Field strengths from fixed transmitters, such as base stations for radio (cellular/cordless) telephones and land mobile radios, amateur radio, AM and FM radio broadcast and TV broadcast cannot be predicted theoretically with accuracy.

To assess the electromagnetic environment due to fixed RF transmitters, an electromagnetic site survey should be considered. If the measured field strength in the location in which the product is used exceeds the applicable RF compliance level above, the product should be observed to verify normal operation. If abnormal performance is observed, additional measures may be necessary, such as re-orienting or relocating the product.

b: Over the frequency range 150 kHz to 80 MHz, field strengths should be less than 3 V/m.

### Recommended Separation Distances Between Portable and Mobile RF Communications Equipment and the Product

The product is intended for use in an electromagnetic environment in which radiated RF disturbances are controlled. The customer or the user of the product can help prevent electromagnetic interference by maintaining a minimum distance between portable and mobile RF communications equipment (transmitters) and the product as recommended below, according to the maximum output power of the communications equipment.

	Separation distance according to frequency of transmitter (m)		
Rated maximum output power of transmitter (W)	150 KHz to 80 MHz $d = 12\sqrt{P}$	80 MHz to 800 MHz $d = 12\sqrt{P}$	800 MHz to 2.5 GHz $d = 2,3\sqrt{P}$

0.01	0.12	0.12	0.23
0.1	0.38	0.38	0.73
1	1.2	1.2	2.3
10	3.8	3.8	7.3
100	12	12	23

For transmitters rated at a maximum output power not listed above, the recommended separation distance in metres (m) can be estimated using the equation applicable to the frequency of the transmitter, where P is the maximum output power rating of the transmitter in watts (W) according to the transmitter manufacturer.

NOTE 1: At 80 MHz and 800 MHz, the separation distance for the higher frequency range applies.

NOTE 2: These guidelines may not apply in all situations. Electromagnetic propagation is affected by absorption and reflection from structures, objects and people.

### After service and warranty instruction

#### 1 Period validity:

Five year's free repair for the main unit, one year's free repair for the handpiece from the date of purchase. Lifetime maintenance.

#### 2 Range of warranty:

Within the warranty period of validity, we are responsible for any troubles caused by quality problems or products technique and structure.

#### 3 The followings are beyond our warranty:

- 1) The damage caused by disobeying the operation instruction or lack of the needed condition.
- 2) The damage caused by unsuitable operation or disassembly without authorization.
- 3) The damage caused by unadvisable transportation or preservation.
- 4) There isn't the seal of distributor or the warranty card isn't filled in completed.

### After service and Warranty Instruction

Name of Customer	
Address	
Post Code	
Tel	
E-mail	
Purchase Date	
Distributor	
Model	
Product No.	
Handpiece No.	
Production Date	